

# Data Sheet



Article number: 432000075

Description: Rota-fix shaft-hub connection A 75x115  
Steel

Note: Not self centering. Medium-high torques.

## Measures

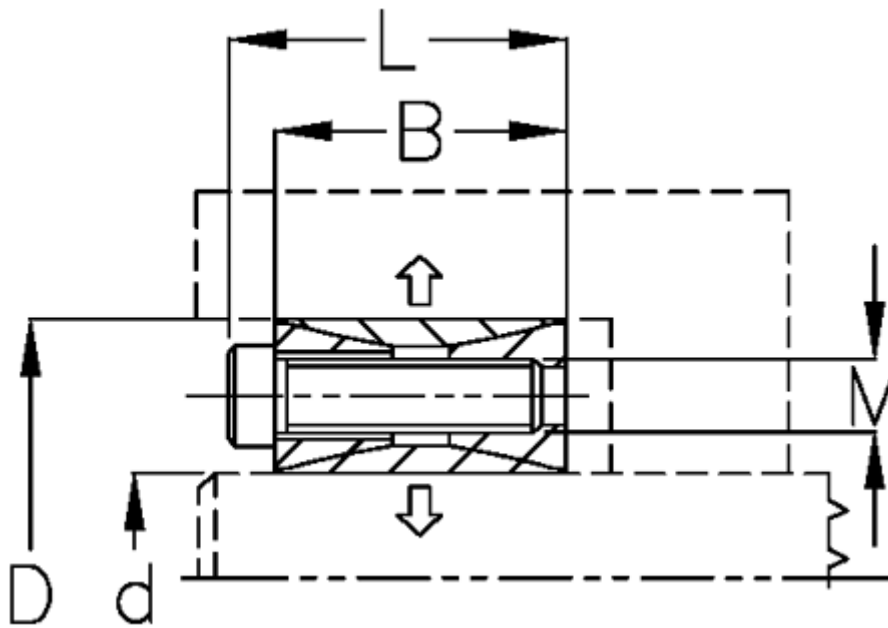

B mm	= 28
d H8 mm	= 75115
D mm	= 115
Fit tolerance	= Aksel k11-h11, Nav N11-H11
F kN torque	= 159.0
L mm	= 38
M mm	= M10
P N/mm <sup>2</sup> surface pressure on shaft/hub	= 153

Surface roughness	=
T N m torque	=
Ts N m bolt tightening torque	=